

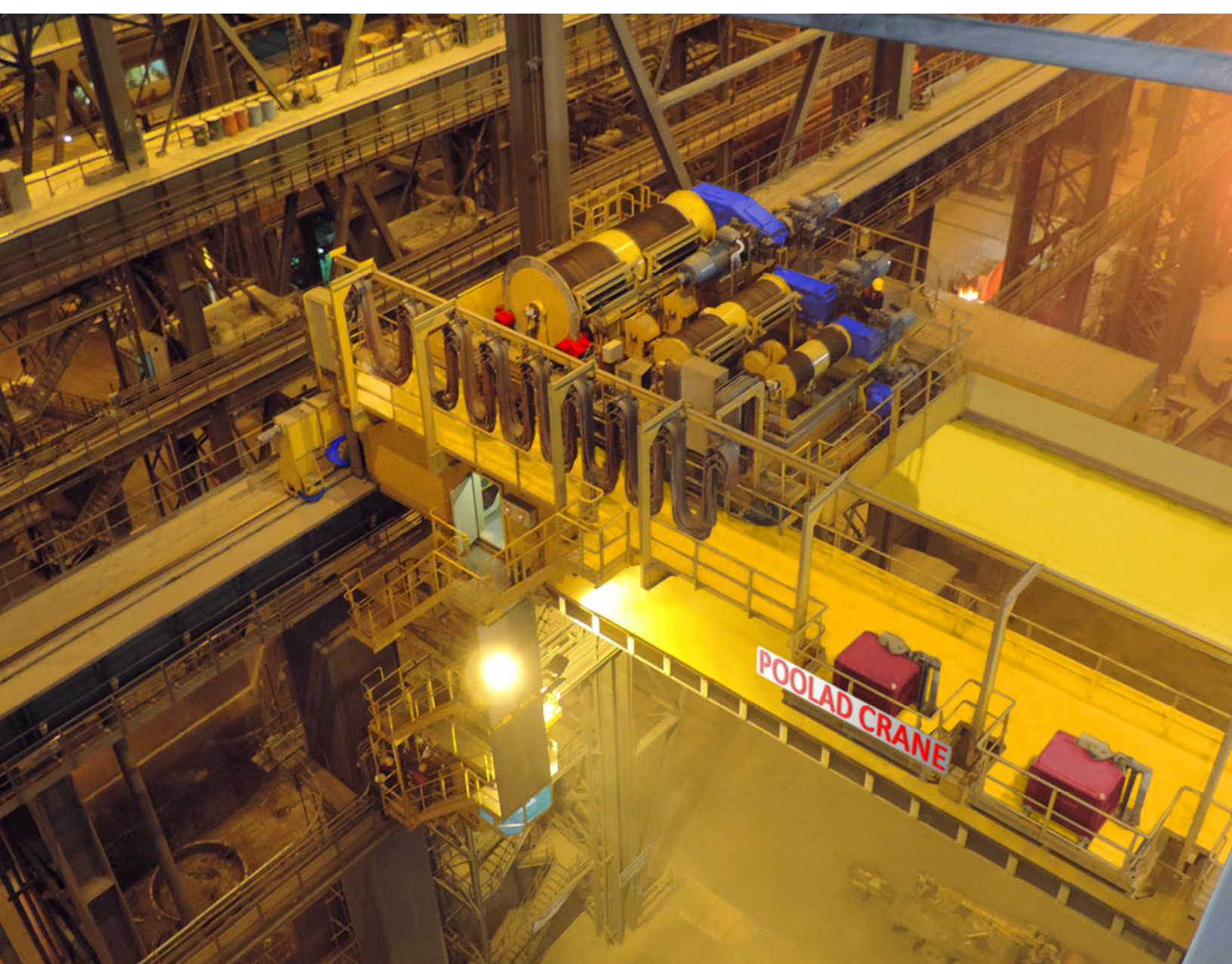

POOLAD CRANE
Materials Handling Equipment

Cranes and Components Materials Handling Equipment



INTRODUCTION



Poolad Crane is one the leading companies in field of cranes systems and materials handling equipment in the world. We have 40 Years of Golden experience. The cranes and components are manufactured in Poolad Crane with highest quality and the latest state of the art technology. Our range of products varies from standard cranes to the extreme heavy duty cranes for steel mills and special purpose. Our products will meet any requirement regarding the place of usage and application.



Furnace Bay – Charging Cranes



Scrap Charging Crane 110/40/10 Ton x 30 meters



Slab Tong Cranes



25+25(50)/10 Ton x 28m - Slab Tong Crane



Furnace Bay – Charging Cranes



High Quality Products
Using first class components



Our cranes are equipped with high-Tech electrical system and control units which will be in accordance of the high precious needs of steel mill industries.

Clients can use the advantages of having back the energy to their system easily.

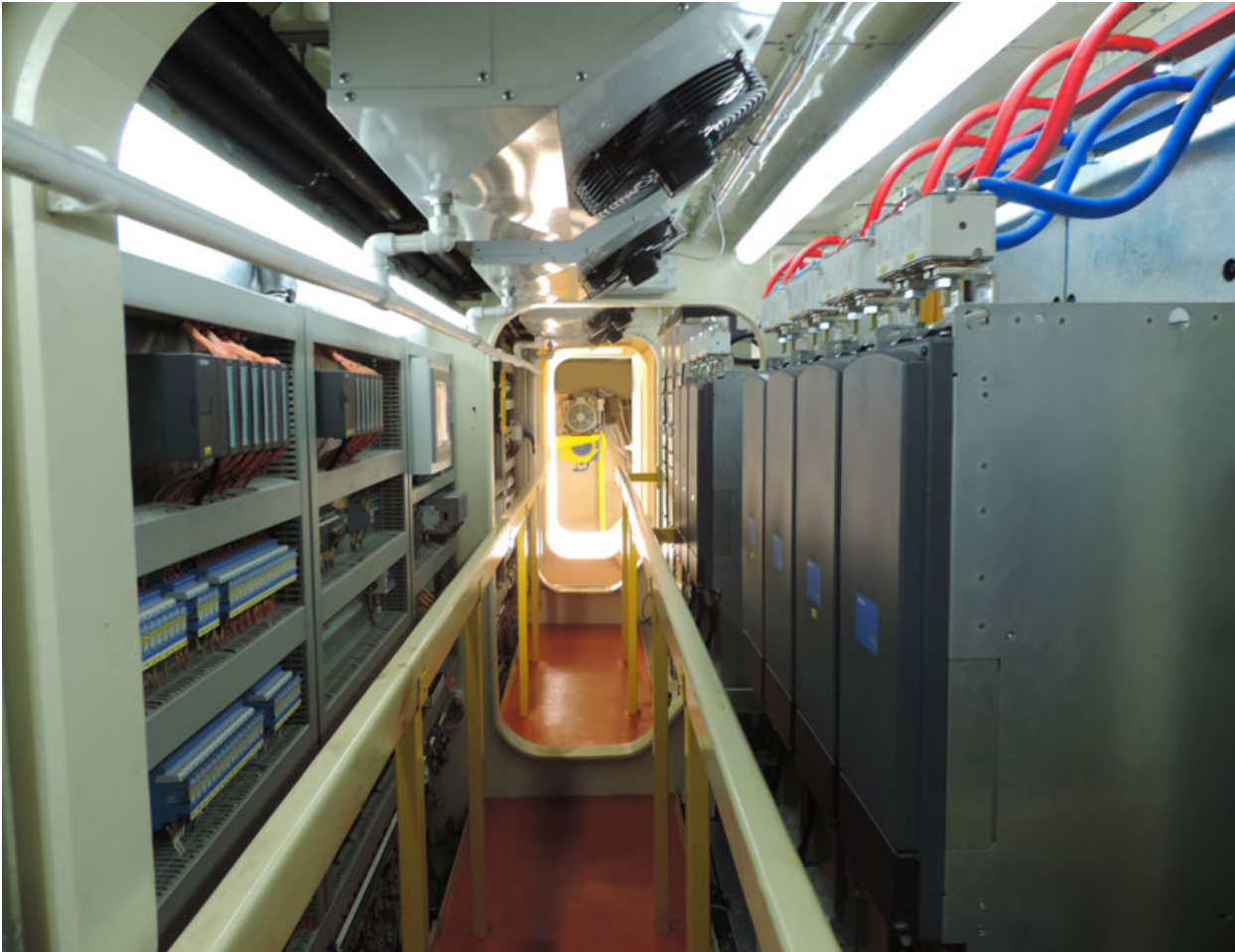

Know-How and Experience have made our products
Reliable and Durable

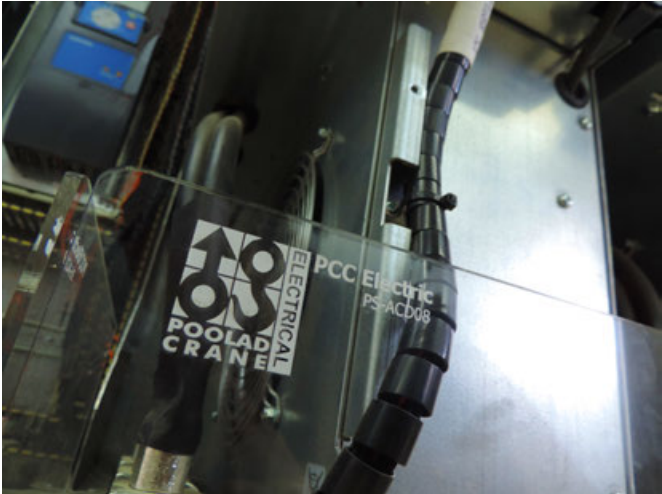

Installation of Heavy Cranes

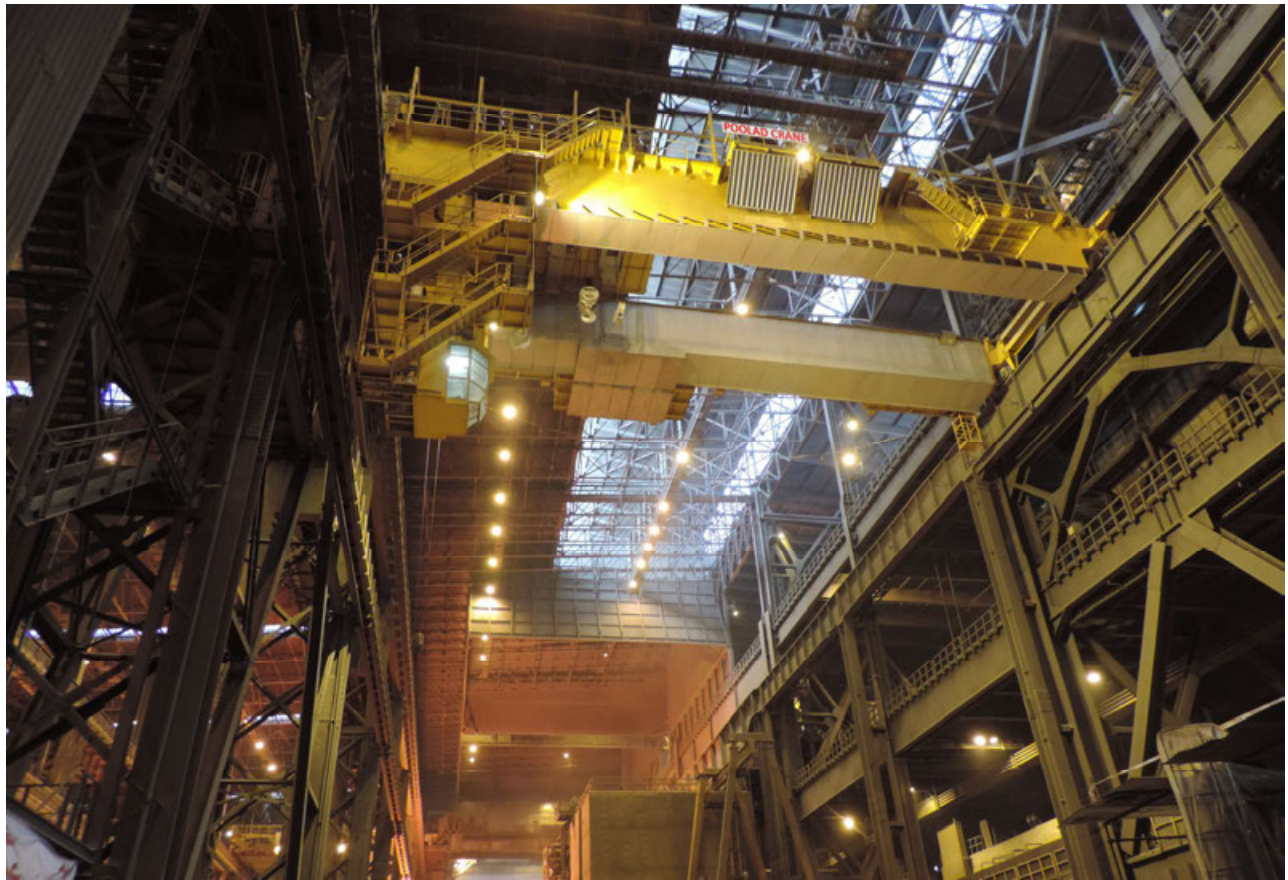

Installation and delivery of crane at site without shutting down the site with highest safety possible



Goliath Gantry Cranes – Coil Handling



One of our favorite and special products is the Gantry Crane at any size, any capacity and Speeds for all industrial application and extreme heavy duties.

Design, Production and Fabrication are based on the latest technology and the state of the art.

We also have successfully installed the Biggest Coil Handling Gantry Crane of Steel Mills in Iran.



Our Products will be adapted for any application, ambient, conditions and also custom needs of our customers.



Scrap Yard Cranes – Magnet / Grab

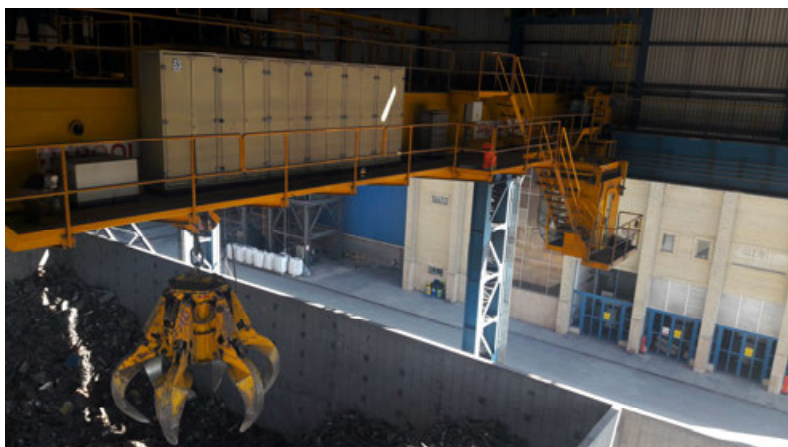

Scrap Yard Cranes are one of the most important and extreme heavy-duty types of cranes in a steel mill.

Scrap Yard Cranes are normally equipped with Magnet or Grab or both of them at the same time, based on the choice of customers, and the exclusive specification and requirements of design.

Classification of Scrap yard cranes are mainly A7-M7 & A8-M8

Poolad Crane’s Scrap Yard Cranes will meet all of the standards requirements and also will be fit with the extreme conditions and environment of the scrap yard of steel mill industries.



Tundish Cranes with Movable Cabins



As in some of the steel mill cranes the perfect view of the operators from the Cabin is required and as the wide span of the cranes, then the moveable operator's Cabin will be designed, which allows the cabin to move all along the span of crane, separately and independent to the trolley frame to be on the right position



320/110/40 Ton - Ladle Crane



In May 2017 one of the biggest and hardest refurbishment and reinforcement of the heaviest crane structure on the steel mill, the a four girder ladle crane 320/110/40 Ton, was executed by our team, the desired time schedule of project was kept and the crane was tested by 400 Ton after refurbishments and get back to work successfully.

The main point of this hard job was that the crane was not dismantled for repair works and all the activities were done, when the crane was still on the runways.

The crane was fixed with a strong supporting structure, while the crane repair works was ongoing. The main trolley and the auxiliary trolley with the weight of 250,000 Kg were lifted and were fixed.

The collaboration of all team lead the project to one of the other successful stories in the history of Poolad Crane.

Shipment of Heavy Cranes



A SUCCESS STORY - Shipment Based on the Safety Regulations



460-Ton Turbine Hall Cranes



Power Plants Cranes & Components



Caspian Power Plant Project



Cranes for Special Purpose



65/16/10 Ton Crane and other 8 Sets cranes for export to Iraq



Process Cranes

Steel Making Plant
Oxygen Plant
EOT Crane
45 Ton



Steel Mill Plant
Gantry Crane
Grab Hook Duty

Steel Making Plant
Ladle Maintenance Workshop
Multi-Purpose Gantry Crane



Steel Mill Crane – Billet Bay



Steel Making Plant – Billet Bay Crane – FEM Classification A8 M8



Roll Shop – Cranes 35/15 Ton

Software for Design & Simulation

Together with our experience, we also use the latest software for design and analyze of our products

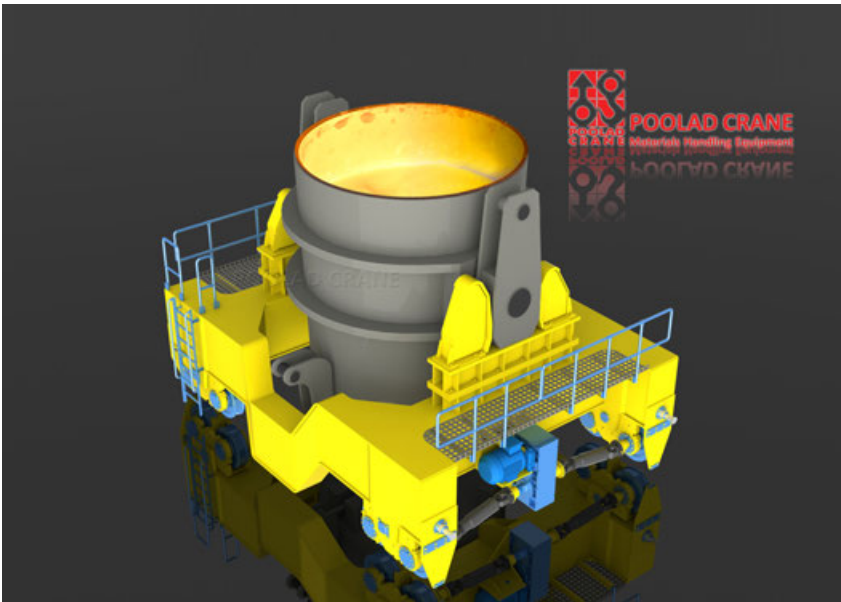
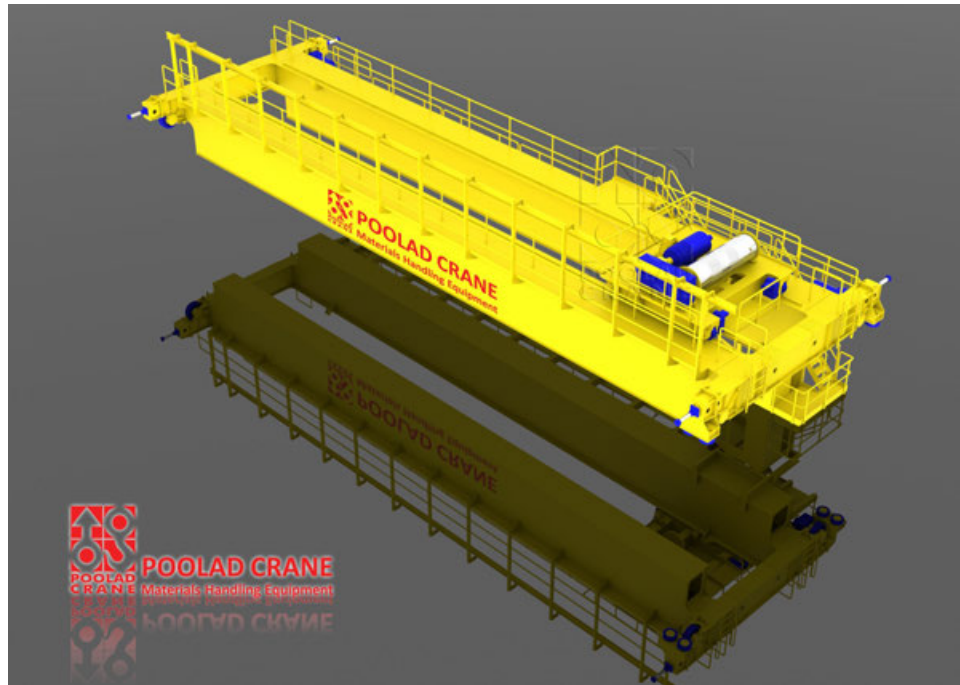

Steel Mill Plant
Transfer Cars
Capacity: 270-Ton

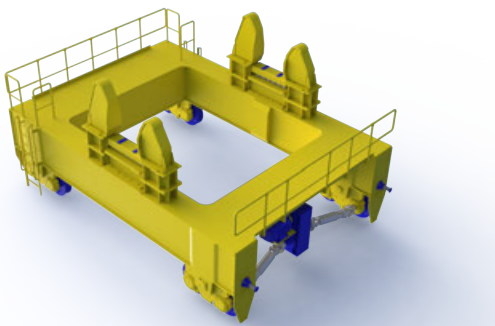
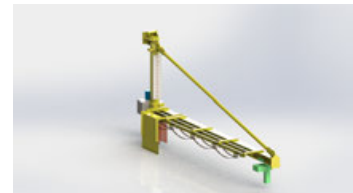

First Class Engineering Services

We present to our special steel mill clients our first class engineering services, one of the biggest issue in this field was the upgrading, refurbishment and capacity increasing of 3-sets of charging cranes in steel mill from 275-Ton to 300-Ton, the project was done according to the needs and technical requirements of the client.



Upgrading and presenting the solution to solve the problems of scrap charging cranes 100/25-Ton in steel mill.



Press Shops Cranes – Transfer Cars

IHDM
17 Sets EOT Cranes
from 5 to 40 Ton
Press Shops
Process Cranes



Saipa Press
11 Sets EOT Cranes from
12.5 to 40/10 Ton
Press Shops
Process Cranes

75-Ton Bogie
Transfer Car
Dies Handling
Press Shops



Heavy Duty Cranes

Siah Bishe Dam
EOT Cranes 25/5 Ton
2 Sets

Extreme heavy duty cranes
Installed on the hard condition
of underground with so many
explosion on this environment
the cranes did the perfect job to
help the client continue working
The cranes were designed to
work on two different spans.



Gotvand Dam
Kian Payab
EOT Cranes
2x20(40)Ton
2 Sets



Coating of offshore Pipes
EOT Cranes
2x16 Ton

Dam Spillway Gantry Cranes



Dam Crane –Gantry Crane 40/3.2 Ton – with 8 meters outreach access for gate maintenance



Gantry Cranes for Precious Lifting



Dam— Gantry Crane 40/5
Ton with 50 meters lifting
height for installation of
the pipes of dam.

250-Ton Locomotive Turn Table



Honored to be the Number one in manufacturing of 250-Ton Locomotive Turn Table and Locomotive transfer table for the Railway Company, and to be the one of the biggest suppliers of these types of machines in the world with many Stations equipped with our machines



250-Ton Locomotive Transfer Table



IRI - Railway Company
Locomotive Transfer Table
250-Ton



Multi-Purpose Gantry Cranes



Poolad Crane Co. – Gantry Crane 50-Ton – Length of Girder 36 meters

Heavy Machinery & CNC Machines



In our production line we have the huge and big heavy machinery equipment which allows and makes our products to be delivered on time and also the quality to be at the highest level possible.

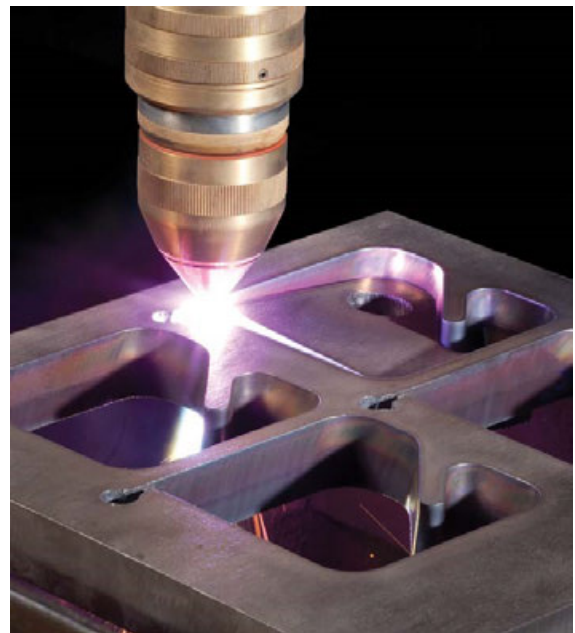

Complete Manufacturing Facilities



Gantry Cranes
at Poolad Crane's
factory
50 Ton x 36 meters
20 Ton x 36 meters

Heavy Lathe Machine
Machining line
For manufacturing of heavy duty cranes drums



Complete range of machines and equipment for manufacturing of heavy duty cranes

Experience and Success



References

- Some of our recent and present projects are as follow:

No.	Crane / Equipment	QTY	Capacity	Fem Class.	Span /Length	Customer	Project /Supply
1	Furnace Charging Crane	1	110/40/10 Ton	A7 M7	30 m	Mobarakeh Steel Co.	
2	Slab Tong Crane	2	25+25(50)/10 Ton	A8 M8	28 m	Mobarakeh Steel Co.	
3	Furnace Charging Crane	2	110/40/10 Ton	A7 M7	30 m	Mobarakeh Steel Co.	
4	Turbin Hall Crane	2	460/30 Ton (230+230)	A4 M4	31 m	UEDCo.	
5	Teeming Crane	1	320/110/32 Ton	A8 M8	20 m	Mobarakeh Steel Co.	Rufurbishment
6	Ladle Crane	3	275/40 Ton	A8 M8	22 m	Khuzestan Steel Co.	Eng. Capacity Increasing
7	Furnace Charging Crane	3	100/40 Ton	A8 M8	26 m	Khuzestan Steel Co.	Inspection and Solutions
8	Ladle Handling Crane	1	85/35 Ton	A7 M7	30 m	Hormozgan Steel	
9	EAF Ladle Car	1	270 Ton	A8 M8	120 m	Chadormalu mining & Industrial Co	Engineering
10	LF Ladle Car	1	270 Ton	A8 M8	100 m	Chadormalu mining & Industrial Co	Engineering
11	Ladle Inter Bay Car	1	270 Ton	A8 M8	80 m	Chadormalu mining & Industrial Co	Engineering
12	Scrap Bucket Car	1	170 Ton	A8 M8	60 m	Chadormalu mining & Industrial Co	Engineering
13	Tundish Crane	1	120/40 Ton	A6 M6	28 m	Mobarakeh Steel Co.	
14	Slab Tong Crane	1	60/10 Ton	A8 M8	35.5 m	Mobarakeh Steel Co.	
15	Slab Tong Crane	1	50/10 Ton	A8 M8	35.5 m	Mobarakeh Steel Co.	
16	Slab Tong Crane	1	50/12 Ton	A7 M7	20 m	Mobarakeh Steel Co.	
17	Billet Car	1	17.7 Ton	A8 M8	120 m	Chadormalu mining & Industrial Co	Engineering
18	Billet Bay Crane	1	20 Ton	A8 M8	28 m	Khuzestan Steel Co.	Replacement
19	EOT Cranes	2	25 Ton	A8 M8	30 m	Mobarakeh Steel Co.	Hoist components
20	EOT Cranes	3	35-15 Ton	A6 M6	20 m	Khuzestan Oxin Steel	
21	Oxygen Plant Crane	2	45-25 Ton	A6 M6	24 m	Mobarakeh Steel Co.	
22	Locomotive Transfer Table	2	250 Ton	A7 M7	32 m	Islamic Republic Of Iran Railways	
23	Scrap Yard Crane	2	20 Ton	A8 M8	20 m	Chadormalu mining & Industrial Co	
24	Maintenance Hoists	3	20 Ton	A7 M7	40 m	Khuzestan Steel Co.	
25	Process Crane Crusher line	4	75-15-10 Ton	A6 M6	20 m	Cement Payvand Golestan	
26	Turbine Hall Crane	1	65/16/10 Ton	A6 M6	16 m	Sunir –Ameran Ofogh	

27	Process Crane Crusher line	3	50-10-5 Ton	A6 M6	20 m	Cement Faraz Firouzkouh	
28	Process Crane Press Shop	17	40-32-16 Ton	A6 M6	32 m	IHDM	
29	Process Crane Press Shop	11	40-25-12.5 Ton	A6 M6	24 m	Saipa Press	
30	Gantry Crane	1	42.5/5 Ton	A7 M7	18 m	Kian Payab	
31	Transfer Car Press Shop	1	75 Ton	A7 M7	250 m	Saipa Press	
32	Transfer Car Press Shop	3	45 Ton	A6 M6	60 m	IHDM	
33	EOT Crane	2	25/6 Ton	A7 M7	30 m	Farab	
34	Gantry Crane	1	40/3.2 Ton	A6 M6	30 m	Sadid Jahan Sanat	
35	Special Purpose EOT Crane	1	32/6 Ton	A7 M7	30 m	Islamic Republic Of Iran Railways	
36	Process Crane	2	32 Ton	A7 M7	18 m	SADAF	
37	Ferroalloy Crane/ W.Crane	3	10 Ton	A7 M7	18 m	Chadormalu mining & Industrial Co	
38	Gantry Crane	1	20Ton	A7 M7	30 m	Sadad Machine	
39	Empty Ladle Crane	1	75 Ton	A7 M7	26 m	Hormozgan Steel	Hoist Brake
40	Cable Reel	6	270 Ton	A7 M7	120 m	Mobarakeh Steel Co.	Transfercar
41	Cable Reel	6	150 Ton	A7 M7	100 m	Khorasan Steel Co.	Transfercar
42	Grab Gantry Crane	1	3 Ton	A7 M7	6+8 m	Mobarakeh Steel Co.	
43	Monorails & Hoists	28	3-15 Ton	M6	--	Mobarakeh Steel Co.	
44	Charging Monorails	4	5 Ton	M7	--	Mobarakeh Steel Co.	
45	Turn Table	10	250 Ton	A7 M7	30 m	Islamic Republic Of Iran Railways	
46	Gantry Crane	1	110 Ton	A5 M5	15 m	Kian Payab	
47	Ladle Crane	1	90/35 Ton	A7 M7	28 m	Hormozgan Steel	
48	Oil Buffer	64	70-275 Ton	A8 M8	26 m	Khouzestan Steel Co.	
49	Cranes & Hoists	23	5-20 Ton	A5 M5	20 m	Saba Steel Co.	
50	Cranes & Hoists	6	5-25 Ton	A6 M6	25 m	Kian Payab	
51	Gantry Crane	1	35 Ton	A8 M8	32 m	Mobarakeh Steel Co.	
52	EOT Crane	2	50/16 Ton	A6 M6	30 m	Mobarakeh Steel Co.	Hooks
53	Ladle Crane	4	240/40/5 Ton	A8 M8	26 m	Hormozgan Steel	Hooks
54	Cranes & Monorails	10	15/10/5/2 Ton	A5 M5	18 m	UEDCo.	
55	Hot Slab / Magnet Handling Cranes	8	50/40 & 50/10 Ton	A8 M8	35.5 m	Mobarakeh Steel Co.	Present

Our Valuable Customers



- Some of our valuable customers:



Mobarakeh steel Co.



Hormozgan Steel Co.



Railway of IR IRAN



NISCO – Chahar Mahal



CDTIC



Khouzestan Oxin Steel Co.



Saba Steel



Chadormalu Steel Co.



Pamidco



Saipa Press



United Energy Developers



MMTE Co.



Parhoon Tarh



Mah-Taab Caspian



IHDM



Sunir



Ameran Ofogh



Espandar Cement Co.



Khouzestan Steel Co.



Khorasan Steel Co.



Sadaf



General Mechanic



Sadid Co.



Kian Payab



KWPA Org.



Sharif University



Pargasiran Co.



Golestan Cement Co.



Sadid Pipe & Profile



Butane Co.



Tablieh



Moshanir



Pars Moshabak



Niro Moharekeh



Farab



Wood Group



MME Co.



Shibeh Co.



PS Co.



Indamin Co.



POOLAD CRANE

Address:

No.86, Hossainabad Ave., 8th km of Tehran-Saveh Rd., Tehran - Iran

Postal Code: 3319963435

Website: www.pooladcrane.com/Home

E-Mail: info@pooladcrane.com

E-Catalog: www.pooladcrane.com

Tel.: +98 (0) 21 5524 2879 (6 lines)

Fax: +98 (0) 21 5524 1521